

# IT'S ALL ABOUT CLEAN WATER

## CATALOGUE 2023 - POLYMER BATH FITTINGS







## TAILORED TO OFFER DRIP FREE & LEAK FREE PRODUCTS

With over 25 years of experience and a leading position in the market, Watertec is dedicated to delivering exceptional solutions that perfectly blend form, finish, and functionality. Our extensive range of polymer bath fittings, including taps, valves, showers, mixers, faucets, bathroom accessories, and connection hoses, exemplifies this commitment. Each product is meticulously crafted from high-quality virgin grade engineering polymer, ensuring both elegance and performance.



To achieve the best torque, endurance, pressure, and heat resistance, every product is put through a series of meticulous and demanding tests. The polymer substance is handled scientifically to encourage hygiene in the bathroom environment. These goods are a lifestyle choice that celebrates your bathroom and, more importantly, you! They are finished with cutting-edge design and aesthetically pleasing detailing.

## ON A MISSION TO REVOLUTIONISE BATH SPACES, SINCE 1997.

In 1997, Watertec was established as a joint venture between UMS Group, Watertec Malaysia, and South Asian Investments, Sri Lanka, in Coimbatore, Tamil Nadu. Our primary objective was to revolutionize bath spaces by introducing superior virgin-grade engineering polymer products.

Initially focussing on polymer-based products, we have grown over the years to become a comprehensive provider of end-to-end bathroom and plumbing solutions. Today, we take pride in offering a diverse range of products that are renowned for being drip-free, leak-free, and corrosion-free, ensuring exceptional quality and longevity.

As a market leader in the polymer-based bath fittings sector, we have manufactured and delivered over 32 million units, and our production continues to expand. Our success is driven by our relentless commitment to constantly enhance and diversify our product offerings, both through organic growth and strategic partnerships or acquisitions.

At Watertec, we remain steadfast in our dedication to pushing boundaries and setting new industry standards. Through our expertise and innovative approach, we strive to provide customers with the most reliable and innovative solutions for their bathroom and plumbing needs.





★ ★ ★ ★ ★

# 25

YEARS

OF DELIVERING SUPERIOR BATH EXPERIENCES  
IN INDIA AND ACROSS THE WORLD.





**15,000+**

CHANNEL PARTNERS  
AND DEALER

**35**

BRANCHES

**24**

HOUR DELIVERY  
POLICY

## OUR REACH

Watertec excels in its distribution capabilities, which serve as a significant advantage for the company. With one of the largest distribution networks covering India and select global markets such as the UAE, SAARC countries, Egypt, and South Asian markets, we have established a strong presence.

Our wide and robust distribution network empowers us to offer a remarkable 24-hour delivery policy for our products, ensuring prompt and efficient service to customers across India.

Building upon our success in the Indian and South Asian markets and gaining the trust of our customers, we have expanded our operations into African and Middle Eastern markets. This expansion reflects our commitment to further growth and our dedication to serving customers in new regions.

Through our strategic distribution network and expansion efforts, Watertec is committed to providing exceptional service and meeting the diverse demands of customers on a global scale. We strive to strengthen our position as a leading provider of superior bathroom and plumbing solutions.





## QUALITY CONTROL

The key tenets of Watertec remain the same in every market sector it is currently operating in or seeking to join. The product must be free of leaks, corrosion, and drips. Every step of the manufacturing process demonstrates our unrelenting dedication to quality and unyielding adherence to our core concept. Unlike other brands of bathroom fixtures, which are typically constructed of poor-quality brass carrying high levels of lead that pose major health risks, all our products are produced of virgin-grade engineering polymers.

We do all manufacturing activities internally, supported by cutting-edge technology and exceptional craftsmanship, giving us total control over the entire process and enabling strict quality control.

Our team of highly qualified and experienced engineers uses fully automatic robotic arms and a variety of high-class tools, along with the most up-to-date, industry-defining injection moulding machinery that is imported from reputable brands in Europe, advanced robotics from Japan, and extruders from reputable brands in India, to guarantee that all products achieve consistency in design and finish while delivering a high level of efficiency.

Every product is put through a number of tests, including torque, endurance, pressure, heat resistance, and salt spray tests, thanks to our strict quality control. All Watertec products are distinguished by their exceptional quality, use of premium raw materials, tried-and-true operation, ease of installation, along with lifetime warranties.



## OUTSIDE THE WALL SOLUTIONS



## OUR 3 - PRONGED PRODUCT PORTFOLIO



**INSIDE THE WALL SOLUTIONS**

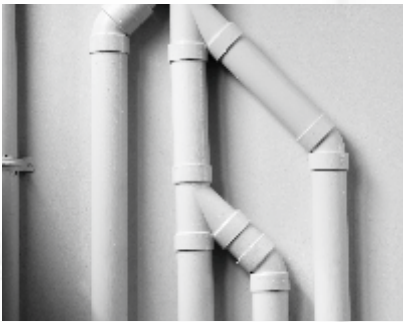

**BEHIND THE WALL SOLUTIONS**



# CERTIFICATIONS

## AND STANDARDS COMPLIANCE

Watertec is an ISO 9001:2015 certified company,  
Quality Management System certification from TUV SUD

### Our Licenses

IS 15778

IS 13592

IS 14735

### Our Standards Compliance

BS EN 200

ASTM D 2846

ASTM D 2467

ASTM D 1785

IS 7834

IS 554

### Our Approvals

IAPMO, WEP-1

NSF - 14, 61 and 372

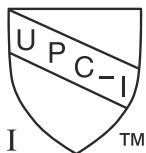



**WE OFFER FREE LIFE-TIME SERVICE WARRANTY! \***  
**JUST A CALL AWAY...**



## **WATER CAPTAIN!**

**is here to save the day, driving all plumbing & bathroom related problems away.**

For the longest time, the customers have faced all kinds of plumbing & bathroom related problems – leakage, seepage, dripping, clogging, lack of hygiene, impure water and more.

Our Water Captain is armed with unmatched technical knowledge, indigenous ideas and an incredibly wide range of new-age plumbing & bathroom solutions, he can provide the right solution for every problem, all with a friendly smile.

Enjoy the benefit from the knowledge, power and trustworthy solutions from Water Captain. All you have to do is give a call on 1800 1212191 and Water Captain will be there!

\*Conditions apply

# THE FIRST STEP OF OUR JOURNEY BEGINS WITH INNOVATION

NEW PRODUCT INNOVATION AND PRODUCTION

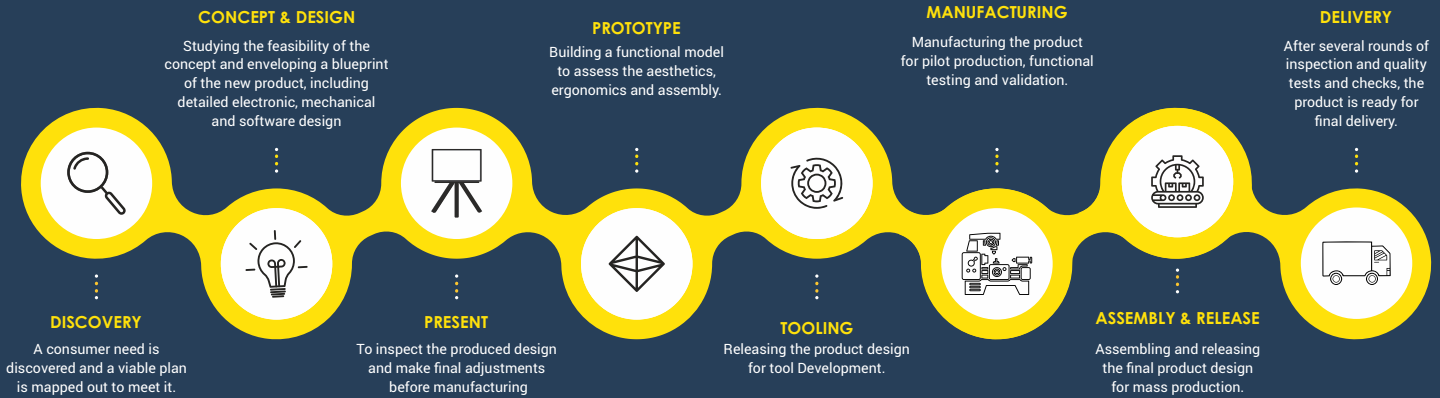

**PRECISION IS WHAT  
MAKES US  
WHO WE ARE!**

Watertec takes great pride in its in-house Tool Room, which plays a crucial role in our commitment to delivering quality and precision. Equipped with a comprehensive range of Tool & Die facilities, we have the capability to build precise injection molds and produce components in large quantities.

Our Tool Room is equipped with advanced German machines renowned for their exceptional quality molds. These molds possess key properties that include high thermal insulation, precise accuracy, compact design, sturdy surface strength, and an anti-abrasive finish.



To ensure the highest level of efficiency and precision, we utilize cutting-edge machinery such as CNC MAZAK and EXERON Milling Machines. The design and programming aspects are handled by Cimatron software, enabling us to achieve optimal results.

Our dedicated team of skilled personnel closely monitors and oversees every stage of the molding process. From design and procurement to manufacturing, sizing, core cavity rough milling, heat treatment, assembly, testing, quality control, and mass production, we maintain meticulous attention to detail.





## SPRAWLING 4.0 COMPLAINT INDUSTRY FACILITY

Watertec is experiencing substantial growth, bolstered by a workforce of 1700 individuals and a sales force of 340 professionals. As a result, we have emerged as one of the leading manufacturers in India, producing over 30 million units of bath fittings annually.

Our manufacturing units operate on the principles of Industry 4.0, aligning with the latest frameworks and technologies. Our newest facility is equipped with state-of-the-art manufacturing equipment, including robotics and automated machinery, setting new benchmarks for excellence. While automation and technology are vital, we also recognize the importance of skilled personnel in our production strategy.

Covering an expansive area of 7,00,000 square meters, our manufacturing facilities span across three units. These facilities house cutting-edge machinery, ensuring that we remain at the forefront of innovation and efficiency in our industry.

At Watertec, we are committed to maintaining exceptional manufacturing capabilities by striking the right balance between advanced technology and a skilled workforce. This approach enables us to consistently deliver high-quality bath fittings that meet the evolving demands of our valued customers.

# ENGINEERED TO SAVE WATER, DESIGNED TO DELIGHT CONFORMING TO BHARATH TAPS STANDARDS



Pressure Compensating Washer (PCW)



## ADJUSTABLE SHOWER

Showers with Pressure Compensating Washer (PCW)

Condition	1.0 Bar	2 Bar	3 Bar
<b>Flowrate - Litres / Minute</b>			
Standard Adjustable Shower	6.5ltrs	10.25ltrs	12.50ltrs
Water saving Adjustable Shower	4.25ltrs	7.0ltrs	8.4ltrs
<b>Water Saving %</b>	35%	32%	33%
<b>Time required to fill 3 ltrs Jar</b>			
Standard Adjustable Shower	29 sec	17 sec	13 sec
Water saving Adjustable Shower	42 sec	25 sec	20 sec



Pressure Compensating Washer (PCW)



## SHOWER

Showers with Pressure Compensating Washer (PCW)

Condition	1.0 Bar	2 Bar	3 Bar
<b>Flowrate - Litres / Minute</b>			
Standard Adjustable Shower	4.2ltrs	9.1ltrs	11.50ltrs
Water saving Adjustable Shower	3.0ltrs	6.0ltrs	7.1ltrs
<b>WATER SAVING %</b>	35%	32%	33%
<b>Time required to fill 3 ltrs Jar</b>			
Standard Adjustable Shower	43 sec	20 sec	15 sec
Water saving Adjustable Shower	61 sec	38 sec	27 sec



Pressure Compensating Washer (PCW)

## BIB TAP

Bib Tap with Pressure Compensating Washer (PCW)

Condition	1.0 Bar	2 Bar	3 Bar
<b>Flowrate - Litres / Minute</b>			
Standard Adjustable Bib Tap	6.5ltrs	11.0ltrs	13.5ltrs
Water saving Bib Tap	3.9ltrs	6.0ltrs	7.0ltrs
<b>WATER SAVING %</b>	40%	45%	49%
<b>Time required to fill 3 ltrs Jar</b>			
Standard Bib Tap	26 sec	14 sec	12 sec
Water saving Bib Tap	46 sec	26 sec	22 sec



# ENGINEERED TO SAVE WATER, DESIGNED TO DELIGHT CONFORMING TO BHARATH TAPS STANDARDS



Honeycomb Restrictor 1.5 gpm



## WALL MIXER - FULL TURN

Wall Mixer -Honeycomb Restrictor 1.5 gpm

Condition	1.0 Bar	2 Bar	3 Bar
<b>Flowrate - Litres / Minute</b>			
Standard Wall Mixer	7.25ltrs	11.75ltrs	14.25ltrs
Water saving Wall Mixer	2.4	3.1	4.2
Water Saving %	67%	74%	71%
<b>Time required to fill 3 ltrs Jar</b>			
Standard Wall Mixer	29 sec	15 sec	13 sec
Water saving Wall Mixer	1min,45sec	1min,02sec	49sec



Honeycomb Restrictor 1.5 gpm



## WALL MIXER - FULL TURN

Wall Mixer -Honeycomb Restrictor 1.5 gpm

Condition	1.0 Bar	2 Bar	3 Bar
<b>Flowrate - Litres / Minute</b>			
Standard Wall Mixer	6.0ltrs	10.25ltrs	13.10 ltrs
Water saving Wall Mixer	2.2	2.9	3.8
Water Saving %	63%	72%	71%
<b>Time required to fill 3 ltrs Jar</b>			
Standard Wall Mixer	36 sec	21 sec	19 sec
Water saving Wall Mixer	1min,58sec	1min,10sec	50sec



## BASIN MIXER

Basin Mixer-Honeycomb PCA Spray 1.0 gpm

Condition	1.0 Bar	2 Bar	3 Bar
<b>Flowrate - Litres / Minute</b>			
Standard Basin Mixer	3.75ltrs	8.5ltrs	10.70ltrs
Water saving Basin Mixer	1.6	3.4	3.75
Water Saving %	67%	74%	71%
<b>Time required to fill 3 ltrs Jar</b>			
Standard Basin Mixer	53 sec	22 sec	17 sec
Water saving Basin Mixer	1min,50sec	54 sec	50sec

# CONTENTS

- 19** M SERIES
- 24** LITE SERIES
- 34** SQ SERIES
- 36** BATH & SHOWER MIXER
- 39** BASIN MIXER
- 42** PRESSMATIC
- 44** SHOWERS
- 46** HEALTH FAUCET
- 50** BATHROOM ACCESSORIES
- 55** TOILET SEAT COVERS
- 57** CISTERNS
- 59** CONCEALED CISTERN
- 60** ALLIED





ECO-101001  
**MAGIX BIB COCK**

Available Colours  
White



ECO-101002  
**SMART TAP**

Available Colours  
White



ECO-101004  
**MAGIX HEALTH  
FACUET 1 Mtr.**

Available Colours  
White, Almond Apricot



ECO-101003  
**MAGIX RIGHT ANGLE  
STOP VALVE**

Available Colours  
White



# T Series



TS-102001

## **BIB TAP**

Available Colours  
White, Black



TS-102003

## **GARDEN TAP**

Available Colours  
White



TS-102002

## **RIGHT ANGLE STOP VALVE**

Available Colours  
White



TS-102004

## **180mm LONG BODY BIB TAP**

Available Colours  
White





M  
S  
E  
R  
I  
E  
S



# M Series



**MS-103001**

**BIB TAP**

Available Colours  
White, Almond, Apricot,  
Green, Light Blue,  
Burgandy, Charcoal



**MS-103002**

**BIB TAP WITH FLANGE**

Available Colours  
White, Almond, Apricot,  
Green, Light Blue,  
Burgandy, Charcoal



**MS-103003**

**2 WAY BIB TAP**

Available Colours  
White, Almond, Apricot,  
Green, Light Blue,  
Burgandy, Charcoal



**MS-103004**

**PILLAR TAP**

Available Colours  
White, Almond, Apricot,  
Green, Light Blue,  
Burgandy, Charcoal



**MS-103025**

**CONCEALED VALVE  
WITH FLANGE 20MM**

Available Colours  
White, Almond, Apricot,  
Green, Light Blue,  
Burgandy, Charcoal



**MS-103006**

**RIGHT ANGLE STOP  
VALVE**

Available Colours  
White, Almond, Apricot,  
Green, Light Blue,  
Burgandy, Charcoal



**MS-103007**

**2 WAY RIGHT ANGLE  
STOP VALVE**

Available Colours  
White, Almond, Apricot,  
Green, Light Blue,  
Burgandy, Charcoal



**MS-103008**

**PREMIUM PILLAR TAP**

Available Colours  
White, Almond, Charcoal



# M Series



MS-103009  
**180mm LONG BODY  
BIB TAP**

Available Colours  
White, Almond, Apricot,  
Green, Light Blue,  
Burgandy, Charcoal



MS-103010  
**WASHING MACHINE TAP**

Available Colours  
White, Charcoal, Almond



MS-103011  
**GARDEN TAP**

Available Colours  
White, Almond, Charcoal



MS-103012  
**M&M VALVE 15mm**

Available Colours  
White, Almond, Apricot,  
Green, Light Blue,  
Burgandy, Charcoal



MS-103026  
**F&F 15mm Stop Valve**

Available Colours  
White, Charcoal



MS-103029  
**F&F 20mm Stop Valve**

Available Colours  
White, Charcoal



MS-103013  
**BIB TAP**

Available Colours  
White



MS-103014  
**RIGHT ANGLE  
STOP VALVE**

Available Colours  
White





# M Series



MS-103015  
**PREMIUM PILLAR TAP**  
Available Colours  
White



MS-103016  
**SINK TAP TABLE MOUNTED SHORT SPOUT**  
Available Colours  
White, Almond, Apricot, Green, Light Blue, Burgandy, Charcoal



MS-103017  
**SINK TAP WALL MOUNTED LONG SPOUT**  
Available Colours  
White, Almond, Apricot, Green, Light Blue, Burgandy, Charcoal



MS-103018  
**ANGULAR WALL SINK TAP SHORT SPOUT**  
Available Colours  
White, Almond, Apricot, Green, Light Blue, Burgandy, Charcoal



MS-103019  
**ANGULAR WALL SINK TAP LONG SPOUT**  
Available Colours  
White, Almond, Apricot, Green, Light Blue, Burgandy, Charcoal



MS-103020  
**KITCHEN SINK MIXER**  
Available Colours  
White, Charcoal



MS-103021  
**20mm CONCEALED VALVE uPVC - POLYMER**  
Available Colours  
White



MS-103022  
**20mm CONCEALED VALVE CPVC - POLYMER**  
Available Colours  
White





MS-103023  
**20MM CONCEALED  
VALVE UPVC-CHROME**



MS-103024  
**20MM CONCEALED  
VALVE CPVC-CHROME**



MS-103005  
**WALL MIXER  
(FULL TURN)**

Available Colours  
White, Almond, Apricot,  
Green, Light Blue,  
Burgandy, Charcoal





EVL-145001  
**BIB TAP**  
Available Colours

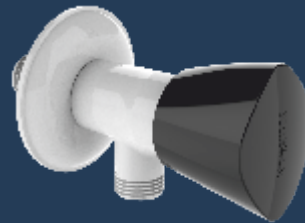

EVL-145002  
**RIGHT ANGLE  
STOP VALVE**  
Available Colours



EVL-145003  
**PILLAR TAP**  
Available Colours



EVL-145004  
**WALL SINK TAP  
SHORT SPOUT**  
Available Colours



EVL-145005  
**WALL SINK TAP  
LONG SPOUT**  
Available Colours



EVL-145006  
**2 WAY BIB TAP**  
Available Colours



EVL-145008  
**180mm LONG  
BODY BIB TAP**  
Available Colours



EVL-145009  
**WALL MIXER**  
Available Colours





EVL-145010  
**TABLE SINK TAP  
SHORT SPOUT**  
Available Colours



EVL-145011  
**TABLE SINK TAP  
LONG SPOUT**  
Available Colours

NEW



EVL-145012  
**F&F 15mm STOP VALVE**  
Available Colours

NEW



EVL-145013  
**M&M 15mm STOP VALVE**  
Available Colours

NEW



EVL-145014  
**F&F 20mm STOP VALVE**  
Available Colours

A  
Q  
U  
A

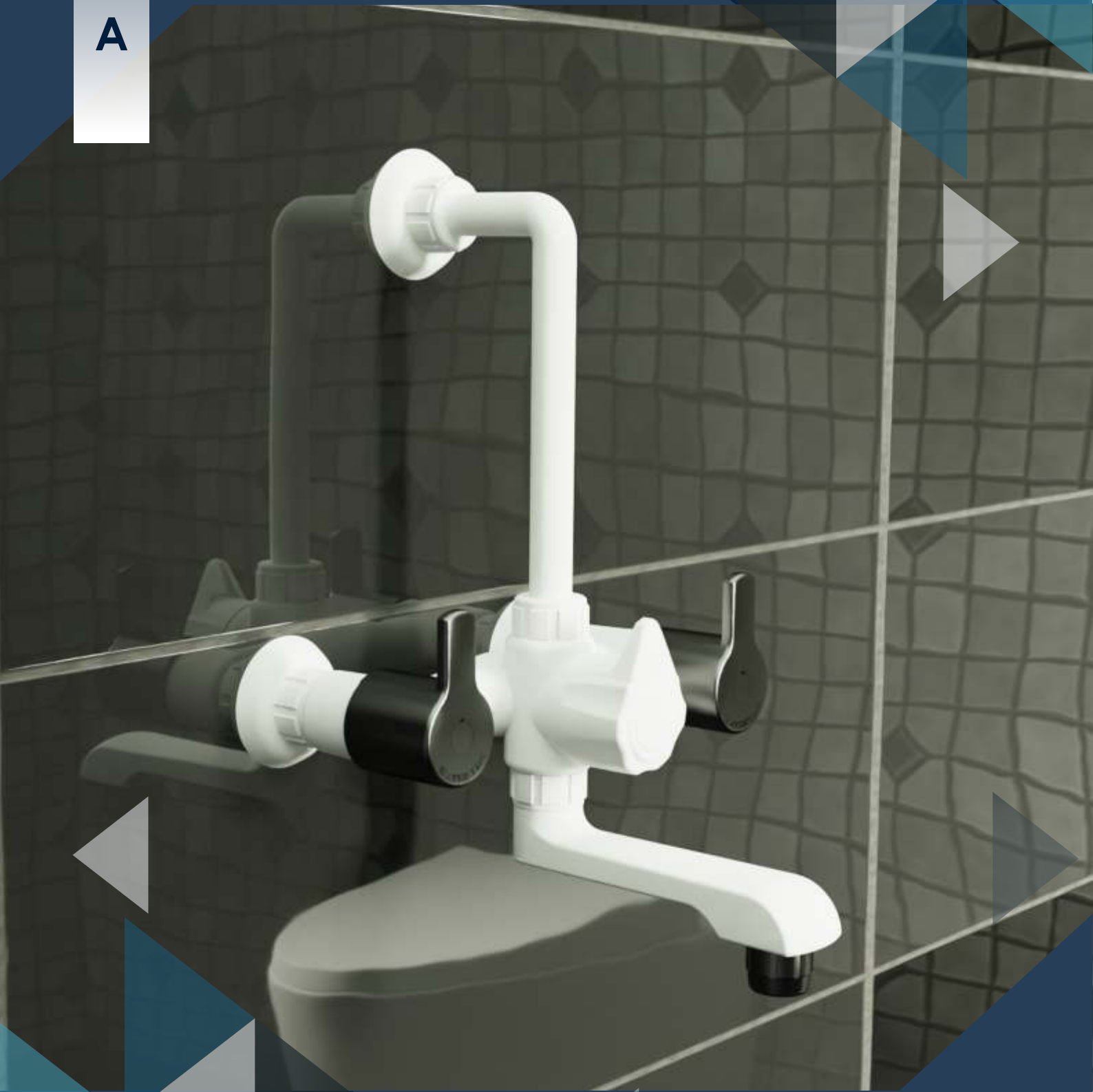



AQL-144001  
**BIB TAP**  
Available Colours



AQL-144002  
**RIGHT ANGLE STOP VALVE**  
Available Colours



AQL-144003  
**PILLAR TAP**  
Available Colours



AQL-144004  
**WALL SINK TAP SHORT SPOUT**  
Available Colours



AQL-144005  
**WALL SINK TAP LONG SPOUT**  
Available Colours

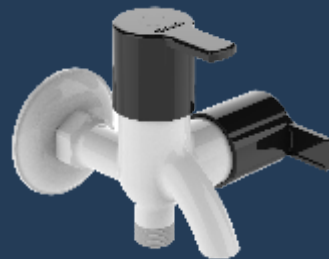

AQL-144006  
**2 WAY BIB TAP**  
Available Colours



AQL-144008  
**180mm LONG BODY BIB TAP**  
Available Colours



AQL-144009  
**WALL MIXER**  
Available Colours





AQL-144010  
**TABLE SINK TAP  
SHORT SPOUT**  
Available Colours



AQL-144011  
**TABLE SINK TAP  
LONG SPOUT**  
Available Colours

NEW



AQL-144012  
**F&F 15mm STOP VALVE**  
Available Colours

NEW



AQL-144013  
**M&M 15mm STOP VALVE**  
Available Colours

NEW



AQL-144014  
**F&F 20mm STOP VALVE**  
Available Colours



ASPL-147001  
**BIB TAP**  
Available Colours



ASPL-147002  
**RIGHT ANGLE STOP VALVE**  
Available Colours



ASPL-147003  
**PILLAR TAP**  
Available Colours



ASPL-147004  
**WALL SINK TAP SHORT SPOUT**  
Available Colours



ASPL-147005  
**WALL SINK TAP LONG SPOUT**  
Available Colours



ASPL-147006  
**2 WAY BIB TAP**  
Available Colours

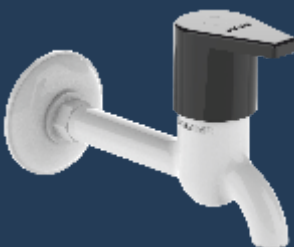

ASPL-147008  
**180mm LONG BODY BIB TAP**  
Available Colours



ASPL-147009  
**WALL MIXER**  
Available Colours



ASPL-147010  
**TABLE SINK TAP  
SHORT SPOUT**  
Available Colours



ASPL-147011  
**TABLE SINK TAP  
LONG SPOUT**  
Available Colours

NEW



ASPL-147012  
**F&F 15mm STOP VALVE**  
Available Colours

NEW



ASPL-147013  
**M&M 15mm STOP VALVE**  
Available Colours

NEW



ASPL-147014  
**F&F 20mm STOP VALVE**  
Available Colours





WATERTEC



EBL-146001  
**BIB TAP**  
Available Colours



EBL-146002  
**RIGHT ANGLE STOP VALVE**  
Available Colours



EBL-146003  
**PILLAR TAP**  
Available Colours



EBL-146004  
**WALL SINK TAP SHORT SPOUT**  
Available Colours



EBL-146005  
**WALL SINK TAP LONG SPOUT**  
Available Colours



EBL-146006  
**2 WAY BIB TAP**  
Available Colours



EBL-146008  
**180mm LONG BODY BIB TAP**  
Available Colours



EBL-146009  
**WALL MIXER**  
Available Colours



EBL-146010  
**TABLE SINK TAP  
SHORT SPOUT**  
Available Colours



EBL-146011  
**TABLE SINK TAP  
LONG SPOUT**  
Available Colours

NEW



EBL-146012  
**F&F 15mm STOP VALVE**  
Available Colours

NEW



EBL-146013  
**M&M 15mm STOP VALVE**  
Available Colours

NEW



EBL-146014  
**F&F 20mm STOP VALVE**  
Available Colours



S  
Q  
S  
E  
R  
I  
E  
S



# SQ Series QTR Turn



SQ-701006  
**Long Body Bib Tap**

Available Colours  
White, Charcoal



SQ-701008  
**Right Angle Stop Valve**

Available Colours  
White, Charcoal



SQ-701004  
**Wall Mixer**

Available Colours  
White, Charcoal



SQ-701011  
**Kitchen Mixer**

Available Colours  
White, Charcoal



SQ-701007  
**Pillar Tap**

Available Colours  
White, Charcoal



SQ-701005  
**2 Way Bib Tap**

Available Colours  
White, Charcoal



SQ-701010  
**Wall Sink Tap**

Available Colours  
White, Charcoal



SQ-701012  
**Garden Tap**

Available Colours  
White, Charcoal



SQ-701013  
**Washing Machine Tap**

Available Colours  
White, Charcoal



**BATH  
&  
SHOWER  
MIXER**



# Bath & Shower Mixer

EBONY



EB-105001

**BATH & SHOWER  
MIXER EXPOSED**

Available Colours



## TECHNICAL SPECIFICATIONS

### BATH & SHOWER

Working Pressure - Min - 1 Bar / Max - 6 Bar

Water Temperature - Max - 80°

Flow Rate - @ 3 Bar Minimum 15 Plm (Spout Side, Mixed Flow)



EB - 105002

**BATH SPOUT  
WITHOUT BUTTON  
POLYMER**

Available Colours



ASPIRE



ASP-107003

**BATH & SHOWER  
MIXER EXPOSED**

Available Colours



ASP-107004

**BATH SPOUT  
WITHOUT BUTTON  
POLYMER**

Available Colours



AQUA



AQ-109012

**BATH & SHOWER  
MIXER EXPOSED  
POLYMER**

Available Colours



AQ-109013

**BATH SPOUT  
WITHOUT BUTTON  
POLYMER**

Available Colours





# Bath & Shower Mixer



CBSM-108001  
**BATH AND SHOWER MIXER CONCEALED**

(Without Cover)



**Final Product**

**B  
A  
S  
I  
N  
  
M  
I  
X  
E  
R**

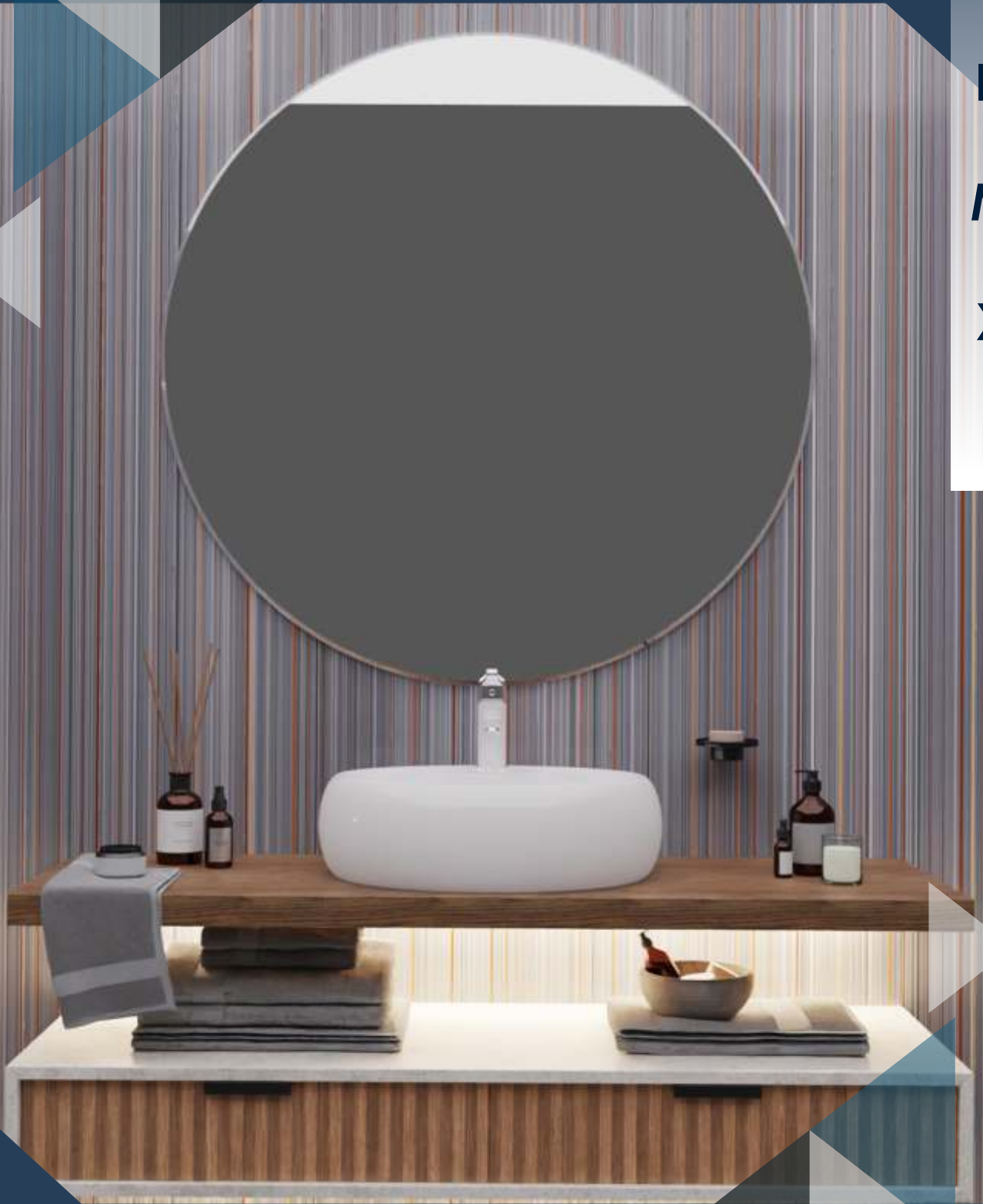

# Basin Mixer

## ICON



IC - 106001  
**BASIN MIXER**  
600mm

IC - 106002  
**BASIN MIXER**  
450mm

## ASPIRE



ASP-107001  
**BASIN MIXER**  
600mm

ASP-107002  
**BASIN MIXER**  
450mm

## AQUA



AQ-109010  
**BASIN MIXER**  
600MM

AQ-109011  
**BASIN MIXER**  
450MM

# Basin Mixer

## Cross Section

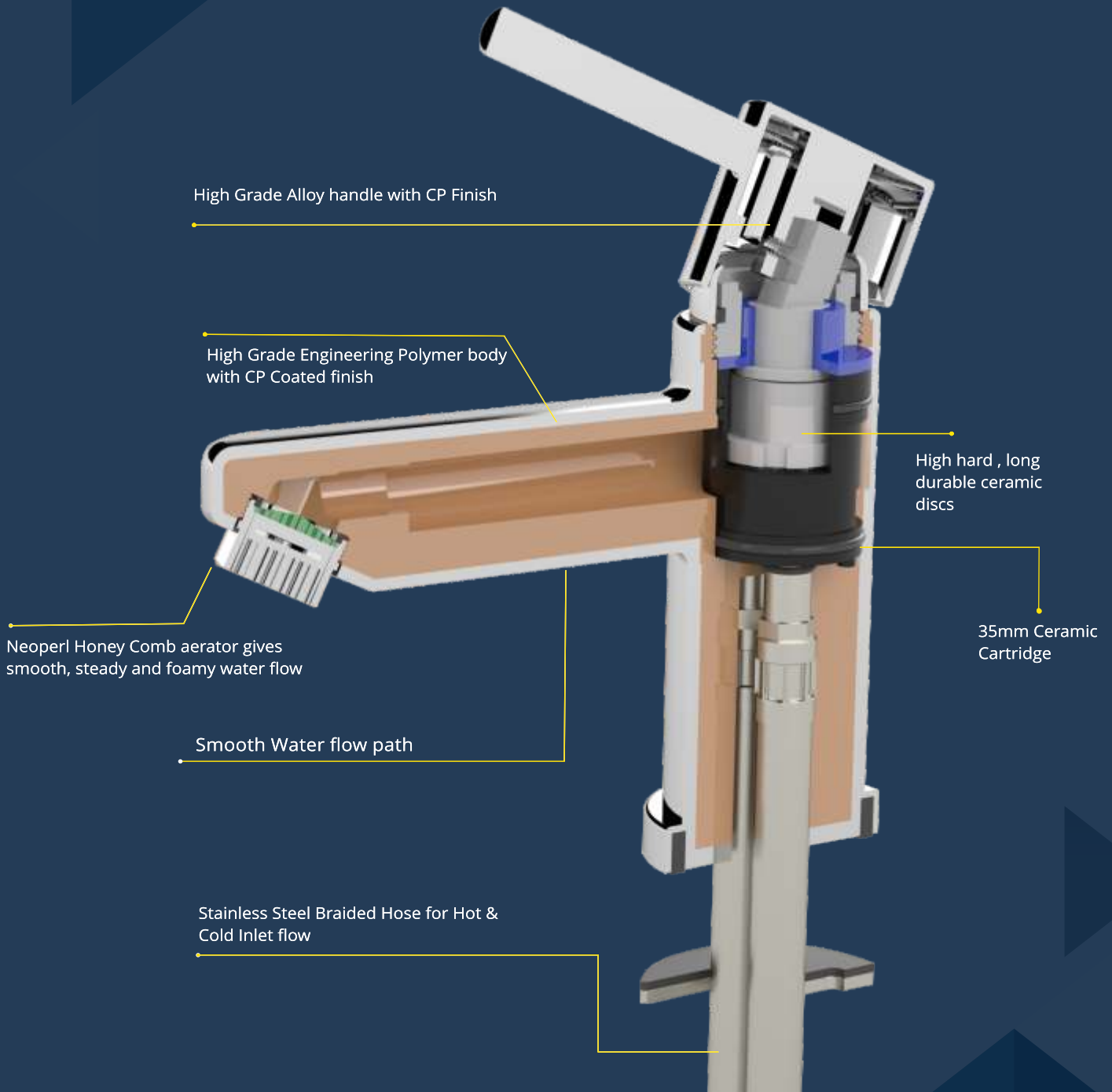



P  
R  
E  
S  
S  
M  
A  
T  
I  
C



NEW



PRSM-112001  
**PUSH COCK - FEMALE**

Available Colours  
White, Almond, Apricot



PRSM-112002  
**URINAL PUSH  
COCK - POLYMER**

Available Colours  
White Almond Apricot



PRSM-112004  
**PUSH COCK WITH  
FLANGE**

Available Colours  
White Almond Apricot



PRSM-112003  
**PRESSMATIC URINAL  
PUSH COCK AUTO CLOSE**

**TECHNICAL SPECIFICATIONS  
PRESSMATIC URINAL**

Single Press – 0.8 To 1.5 Ltrs  
Timing – 10 – 12 Secs  
Actuation Mechanism – Auto Closing  
Working Pressure – 1 – 6 Bar  
Control Cock - Restrict Water Flow  
Upto 1.3 LPM @3 Bar Pressure



PRSM-112005  
**PRESSMATIC PILLAR TAP  
AUTO CLOSE**

**TECHNICAL SPECIFICATIONS  
PRESSMATIC PILLAR COCK**

Single Press – 0.5 To 0.8 Ltrs  
Timing – 6 – 10 Secs  
Actuation Mechanism – Auto Closing  
Working Pressure – 1 – 6 Bar

**S  
H  
O  
W  
E  
R  
S**



# Showers



SH-201001  
**SHOWER 5 A**



SH-201003  
**SHOWER 8 A**



SH-201002  
**SHOWER 5 A - POLYMER**

Available Colours  
White, Almond, Apricot,  
Green, Light Blue, Burgandy



SH-201004  
**SHOWER 8 A - POLYMER**

Available Colours  
White, Almond, Apricot,  
Green, Light Blue, Burgandy



SH-201005  
**DELUXE ADJUSTABLE SHOWER**

Available Colours  
White, Almond, Apricot,  
Green, Light Blue, Burgandy,  
Charcoal



SH-201006  
**HAND SHOWER WITH CONNECTION TUBE**

Available Colours  
White, Almond, Apricot,  
Green, Light Blue, Burgandy



SH-201007  
**Sparkle Hand Shower (Square) with Braided Conn.Hose**



SH-201008  
**Sparkle Hand Shower (Circular) with Braided Conn.Hose**

## Showers Hose



SH-201009  
**Hand Shower Hose Polymer 1.5mtr**

Available Colours



SH-201010  
**Hand Shower Hose Braided 1.5 mtr - 12mm Dia**



SH-201011  
**Hand Shower Hose Flexi 1.5 mtr**



SH-201012  
**Hand Shower Hose Anti Twist Flexi Black - 1.5mtr**



SH-201013  
**Hand Shower Hose Braided Black 1.5 mtr - 12mm Dia**



# Health Faucet



HF-202001  
**WATERLINE 2 IN 1  
HEALTH FAUCET - 1 MTR**

HF-202002  
**WATERLINE 2 IN 1  
HEALTH FAUCET - 1.5 MTR**

Available Colours  
White, Almond, Apricot,  
Green, Light Blue, Burgandy,  
Black



HF-202003  
**ICON - HEALTH FAUCET  
POLYMER - 1 MTR**

HF-202004  
**ICON - HEALTH FAUCET  
POLYMER 1.5 MTR**

Available Colours  
White, Almond



NEW



**SQ** Series  
SQ-701002  
**HEALTH FAUCET - 1 mtr**

SQ-701003  
**HEALTH FAUCET - 1.5 mtr**

Available Colours



HF-202005  
**ICON HEALTH FAUCET  
CHROME WITH  
POLYMER - 1 MTR**

HF-202006  
**ICON HEALTH FAUCET  
CHROME WITH  
POLYMER -1.5 MTR**

NEW



HF-202012  
**ICON HEALTH FAUCET  
POLYMER - BLACK - 1 MTR**

HF-202013  
**ICON HEALTH FAUCET  
POLYMER - BLACK - 1.5 MTR**



HF-202007  
**SLEEK HEALTH FAUCET  
WHITE WITH CHROME**

Available Colours  
White



TECHNICAL SPECIFICATION:  
**SOCKET DIMENSION AS PER  
ASTM D1784**



**UPVC BALL VALVE  
SHORT HANDLE**

MODEL	SIZE
VL-301001	15mm 1/2"
VL-301002	20mm 3/4"
VL-301003	25mm 1"
VL-301004	32mm 1 1/4"
VL-301005	40mm 1 1/2"
VL-301006	50mm 2"

TECHNICAL SPECIFICATION:  
**SOCKET DIMENSION AS PER  
ASTM D1784**



**UPVC BALL VALVE  
LONG HANDLE**

MODEL	SIZE
VL-301007	15mm 1/2"
VL-301008	20mm 3/4"
VL-301009	25mm 1"
VL-301010	32mm 1 1/4"
VL-301011	40mm 1 1/2"
VL-301012	50mm 2"

TECHNICAL SPECIFICATION:  
**SOCKET DIMENSION AS PER  
ASTM F1970**



**CPVC BALL VALVE**

MODEL	SIZE
VL-301013	20mm 3/4"
VL-301014	25mm 1"
VL-301015	32mm 1 1/4"
VL-301016	40mm 1 1/2"
VL-301017	50mm 2"

APPROVED BY

NSF/ANSI 14 & 372



TECHNICAL SPECIFICATION:  
**SOCKET DIMENSION AS PER  
ASTM D1784**



**RPVC BALL VALVE  
THREADED LONG HANDLE**

MODEL	SIZE
VL-301036	20mm 1/2"
VL-301037	25mm 3/4"
VL-301038	32mm 1"
VL-301039	40mm 1 1/4"
VL-301040	50mm 1 1/2"
VL-301041	63mm 2"

TECHNICAL SPECIFICATION:  
**SOCKET DIMENSION AS PER  
ASTM D1784**



**RPVC BALL VALVE  
PLAIN SHORT HANDLE**

MODEL	SIZE
VL-301018	20mm 1/2"
VL-301019	25mm 3/4"
VL-301020	32mm 1"
VL-301021	40mm 1 1/4"
VL-301022	50mm 1 1/2"
VL-301023	63mm 2"

TECHNICAL SPECIFICATION:  
**SOCKET DIMENSION AS PER  
ASTM D1784**



**RPVC BALL VALVE  
PLAIN LONG HANDLE**

MODEL	SIZE
VL-301024	20mm 1/2"
VL-301025	25mm 3/4"
VL-301026	32mm 1"
VL-301027	40mm 1 1/4"
VL-301028	50mm 1 1/2"
VL-301029	63mm 2"

TECHNICAL SPECIFICATION:  
**SOCKET DIMENSION  
AS PER ASTM D1784**



**RPVC BALL VALVE  
THREADED SHORT HANDLE**

MODEL	SIZE
VL-301030	20mm 1/2"
VL-301031	25mm 3/4"
VL-301032	32mm 1"
VL-301033	40mm 1 1/4"
VL-301034	50mm 1 1/2"
VL-301035	63mm 2"

# Valves

## FOOT VALVE SPRING TYPE



MODEL	SIZE
VL-301042	20mm
VL-301043	25mm
VL-301044	32mm
VL-301045	40mm

Available Colours

Black



## FLOAT VALVE WITH ROD & BALL

MODEL	SIZE
VL-301050	15mm
VL-301051	20mm
VL-301052	25mm

Available Colour

Apricot



## FOOT VALVE FLAP TYPE

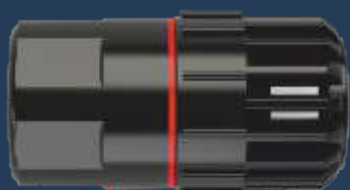

MODEL	SIZE
VL-301046	20mm
VL-301047	25mm
VL-301048	32mm
VL-301049	40mm

Available Colours

Black

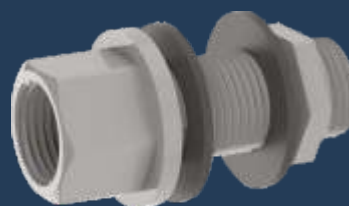

## TANK NIPPLE

MODEL	SIZE
VL-301053	15mm
VL-301054	20mm
VL-301055	25mm

Available Colours

Grey



# Connection Tubes

**TECHNICAL SPECIFICATION:**  
**HEAT RESISTANCE : PRESSURE & TEMPERATURE RATING**  
( Pressure 4 bar @ 70°C )



## PVC CONNECTION TUBE

MODEL	SIZE
CT-401001	1.5 ft
CT-401002	2 ft
CT-401003	1 mtr
CT-401004	1.5 mtr
CT-401005	2 mtr

Available Colours  
White, Almond, Apricot,  
Green, Light Blue, Burgandy



**GEYSER CONNECTION METAL BRAIDED HOSE**  
( Pressure 20 bar @ 90°C )

MODEL	SIZE
CT-401008	15 X 450 mm
CT-401009	15 X 600 mm

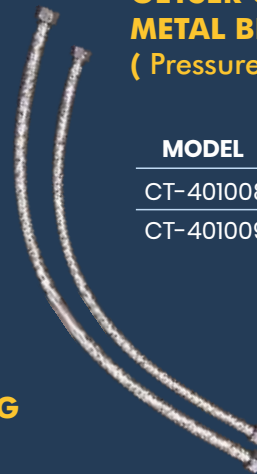

**TECHNICAL SPECIFICATION:**  
**PRESSURE & TEMPERATURE RATING**  
( 16 bar @ 23°C )



## POLYMER BRAIDED CONNECTION TUBE

MODEL	SIZE
CT-401006	1.5 ft
CT-401007	2 ft



**B  
A  
T  
H  
R  
O  
O  
M  
  
A  
C  
C  
E  
S  
S  
O  
R  
I  
E  
S**



# Bathroom Accessories



BA-501001

## BATHROOM CABINET WITH MIRROR

Available Colours



White, Almond, Apricot,  
Light Blue, Green,  
Silky Half White

Size L x W x H : 332mm X 145mm X 430mm  
Mirror Thickness 3mm



BA-501002

## DECK ROLL VERTICAL

Available Colours



Charcoal

Size L x W x H : 235mm X 200mm X 740mm



BA-501003

## RECTANGULAR MIRROR

Available Colours



White, Almond, Apricot,  
Green, Light Blue, Burgandy

Size L x W x H : 545mm X 50mm X 445mm  
Mirror Thickness 3mm



BA-501004

## ROUND MIRROR

Available Colours



White, Almond,  
Red, Black

SIZE

DIA - 340mm X W 15mm

# Bathroom Accessories



BA-501005  
**OVAL MIRROR MAXI**

Available Colours  
White, Almond, Apricot,  
Green, Light Blue,  
Burgandy



SIZE - L x W x H : 450mm X 30mm X 550mm



BA-501006  
**OVAL MIRROR MINI**

Available Colours  
White, Almond, Apricot,  
Green, Light Blue,  
Burgandy



SIZE - L x W x H : 260mm X 28mm X 370mm

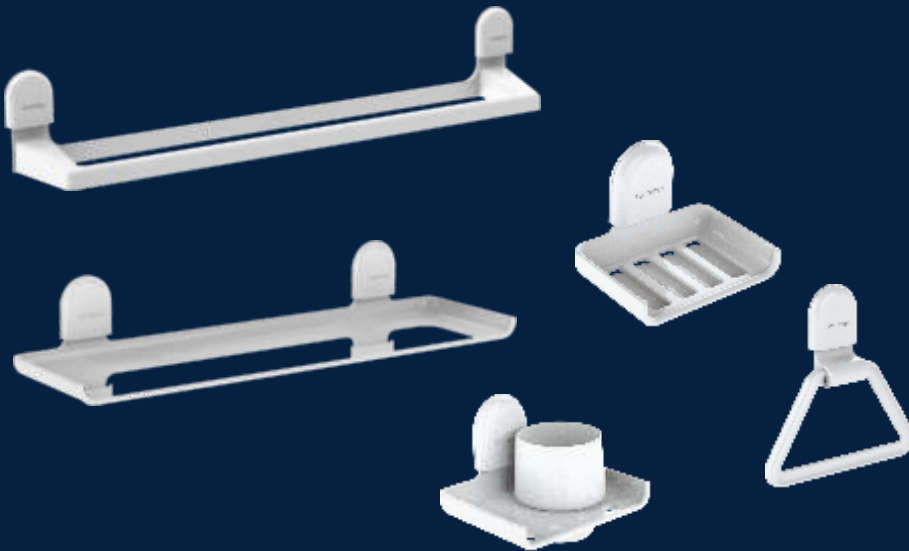

BA-501007  
**BATHROOM ACCESSORIES  
5 PCS SET**

Available Colours  
White, Almond, Apricot,  
Green, Light Blue,  
Burgandy

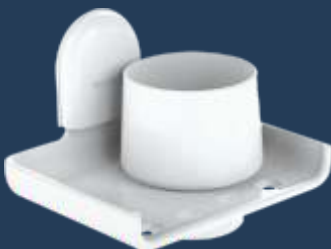

BA-501008  
**TOOTH BRUSH HOLDER**  
Available Colours  
White, Almond, Apricot,  
Green, Light Blue, Burgandy



TUMBLER SIZE - Top Dia 77mm  
Bottom Dia 62mm  
Height 92mm



BA-501009  
**SOAP HOLDER**  
Available Colours  
White, Almond, Apricot,  
Green, Light Blue,  
Burgandy



SIZE - L x W x H : 135mm X 95mm X 100mm

# Bathroom Accessories



**BA-501010**  
**TOWEL HOLDER**

Available Colours  
White, Almond, Apricot,  
Green, Light Blue,  
Burgandy



SIZE - L x W x H : 700mm X 100mm X 95mm



**BA-501011**  
**TOWEL RING**

Available Colours  
White, Almond, Apricot,  
Green, Light Blue,  
Burgandy



SIZE - L x W x H : 180mm X 30mm X 170mm



**BA-501012**  
**DELUXE TOWEL RING**

Available Colours  
White, Almond, Apricot



SIZE - L x W x H : 161mm X 50mm X 80mm



**BA-501013**  
**VANITY SHELF**

Available Colours  
White, Almond, Apricot,  
Green, Light Blue,  
Burgandy



SIZE - L x W x H : 550mm X 150mm X 75mm

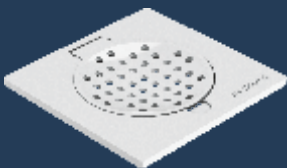

**BA-501014**  
**FLOOR TRAP**

Available Colours  
White, Almond, Apricot,  
Green, Light Blue,  
Burgandy



SIZE - L x W x H : 150mm X 150mm X 20mm

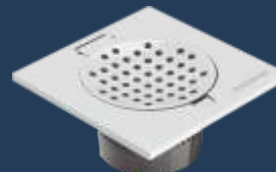

**BA-501015**

**FLOOR TRAP  
WITH GRATING**

Available Colours  
White, Almond, Apricot,  
Green, Light Blue,  
Burgandy



SIZE - L x W x H : 150mm X 150mm X 70mm



# Bathroom Accessories

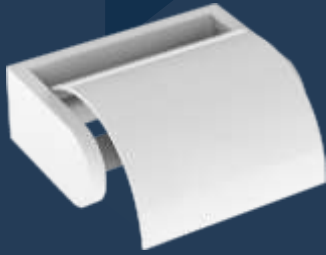

BA-501016

## TOILET TISSUE PAPER HOLDER

Available Colours  
White, Almond



SIZE - L x W x H : 160mm X 90mm X 80mm

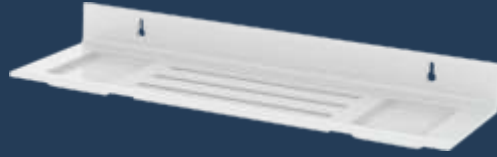

BA-501017

## DOUBLE SOAP AND TOOTH BRUSH SHELF

Available Colours  
White, Almond, Apricot, Green, Light Blue, Burgandy, Charcoal, Transparent



SIZE - L x W x H : 375mm X 115mm X 45mm



BA-501018

## DELUXE SOAP HOLDER

Available Colours



Transparent Red  
Transparent Blue  
Transparent Yellow  
Transparent Green  
Charcoal

SIZE - L x W x H : 140mm X 90mm X 80mm



BA-501019

## LIQUID SOAP DISPENSER CHARCOAL

SIZE - L x W x H : 75mm X 85mm X 180mm



BA-501020

## LIQUID SOAP DISPENSER TRANSPARENT

SIZE - L x W x H : 75mm X 85mm X 180mm

# Toilet Seat Covers



## IDEAL

### MODEL

SC-601001 WHITE

SC-601002 COLOUR

### Available Colours



White, Moon Ivory, Blush Pink, Sage Green, Alpine Blue, New Berly Rose, Indian Ivory, Silky Off White, Ocean Blue, Neycer Blue & Pastel Green

SIZE - L x H : 480mm x 380mm



## SC-601005 SQUATO

Available Colours  
White



SIZE - L x H : 475mm X 342mm



SOFT  
CLOSING



## SC-601006

### LEXO

Available Colours  
White



SIZE - L x H 455mm x 353 mm



SOFT  
CLOSING



## SC-601007 RIVO

Available Colours  
White



SIZE - L x H : 503mm X 362mm



SOFT  
CLOSING

# Toilet Seat Covers



SC-601008

**LIMO**

Available Colours  
White



SIZE - L x H 454mm x 355 mm



SOFT  
CLOSING



SC-601009

**SILO**

Available Colours  
White



SIZE - L x H 483mm x 356 mm



SOFT  
CLOSING



SC-601010

**SASO**

Available Colours  
White



SIZE - L x H 475mm x 340 mm



**SLEEK**

MODEL

SC-601003 WHITE

SC-601004 COLOUR

Available Colours



White, Moon Ivory,  
Silky Off White, Indian Ivory

SIZE - L x H : 370mm x 440mm



## WATERLINE SINGLE FLUSH CISTERN

### MODEL

CSN-602001 WHITE  
CSN-602002 COLOUR

### Available Colours



White, Moon Ivory, Blush Pink, Sage Green, Alpine Blue, New Berly Rose, Indian Ivory, Silky Off White, Ocean Blue, Neycer Blue & Pastel Green

Tank Capacity: 10 Ltr  
Flushing Volume - Min 8 Ltr



## SLEEK SINGLE FLUSH CISTERN

### MODEL

CSN-602003 WHITE  
CSN-602004 COLOR

### Available Colours



White, Moon Ivory, Indian Ivory

Tank Capacity: 8 Ltr  
Flushing Volume - Min 7 Ltr



## WATERLINE DUAL FLUSH CISTERN

### MODEL

CSN-602005 WHITE  
CSN-602006 COLOUR

### Available Colours



White, Moon Ivory

Tank Capacity: 10 Ltr  
Flushing Volume Half - Min 4 Ltr  
Flushing Volume Full - Min 8 Ltr



### SQ Series

SQ-701001

## SINGLE FLUSH CISTERN

### Available Colours

● White

Tank Capacity: 8 Ltr  
Flushing Volume - Min 6 Ltr





ANTI BACTERIAL



ANTIFUNGAL



ANTI-ODOUR

## REGAL DUAL FLUSH CISTERN

TANK CAPACITY: 8 ltr

FLUSHING VOLUME HALF-MIN 3 ltr

FLUSHING VOLUME FULL - MIN 6 ltr



CERTIFIED



**CSN-602027  
BLACK**



**CSN-602028  
GREEN**



**CSN-602029  
GREY**



**CSN-602030  
IVORY**



**CSN-602031  
MAGENTA**



**CSN-602032  
ORANGE**



**CSN-602033  
RED**



**CSN-602034  
BLUE**



**CSN-602035  
WHITE**



**CSN-602036  
YELLOW**



**CSN-602037  
FULL IVORY**

# Concealed Cistern



**FRM 602039HF**  
HALF FRAME



**FRM 602039FF**  
FULL FRAME

## FULL FRAME / HALF FRAME ACCESSORIES

### DISCHARGE PIPE SET



Bend Discharge  
Pipe 100mm



Straight  
Discharge  
Pipe 100mm



SS Rack Bolt  
Acc 602041



C Clamp  
Acc 602041



Pipe Dummy  
Acc 202040



CSN 602038

## CONCEALED CISTERN

L 500mm x W 100mm x H 510mm

Tank Capacity - 8 Ltr

Flushing Volume Half - Min 3 Ltr

Flushing Volume Full - MIN 6 ltr

## CONCEALED CISTERN ACCESSORIES



Bend  
Pipe



Straight  
Pipe



Tank Outlet  
Dummy



Spacer  
Box

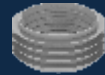

Bellow  
Washer



Mounting  
Clamp

## ACTUATOR PLATE



C 99H  
W 99H

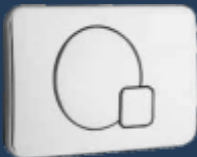

C 99Q  
W 99Q



C 99M  
W 99M



C 99E  
W 99E



C 99W  
W 99W

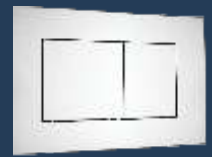

C 99BH

## BLACK

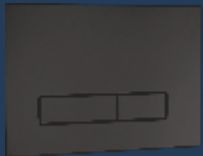

B 99H



B 99Q



B 99E

## GREY



G 99E



G 99H

## GOLD



GO 99E



GO 99H



PN 99W



PN 99B



PN 99R

## PNEUMATIC PUSH PLATE



## WASHING MACHINE OUTLET PIPE

MODEL	LENGTH
ALD-701002	1.5 mtr
ALD-701003	3 mtr

Available Colours  
Grey ●



## WASHING MACHINE INTLET PIPE

MODEL	LENGTH
ALD-701004	1.5 mtr
ALD-701005	2 mtr

Available Colours  
White ●



## ALD-701034

### LONG " L " BEND PIPE

DIA x LENGTH - 40 X 700 mm

Available Colours  
White ●  
Moon Ivory ●



## TANK FILTER

MODEL	SIZE
ALD-701008	¾"
ALD-701009	1"
ALD-701010	1¼"
ALD-701011	1½"
ALD-701012	2"

Available Colours  
Black ●

## TECHNICAL SPECIFICATIONS

### TANK FILTER

Pressure Rating - 8 Bar

Filter Efficiency - Particle Size More Than 130 Microns



## PTFE THREAD SEAL TAPE

MODEL	SIZE
ALD-701015	1/2"
ALD-701016	3/4"



## BOTTLE TRAP

### MODEL

ALD-701017 POLYMER  
ALD-701018 HYBRID

SIZE - L x W x H : 380mm x 65mm x 410mm

Length on inlet & outlet pipe 12 x 12"

Available Colours  
White, White with Chrome





### P - TRAP

MODEL	SIZE
ALD-701043	11"

Available Colours  
White ●



### COLLAPSIBLE WASTE PIPE WITH COUPLER

MODEL	SIZE
ALD-701019	1 1/4"

Available Colours  
White ●



ALD-701022

### WASTE COUPLING TIC TAK POLYMER

Available Colours  
White ●



### WASTE COUPLING FULL / HALF THREAD POLYMER

MODEL	SIZE
ALD-701020 FT	32mm dia / 80mm L
ALD-701020 HT	32mm dia / 80mm L
ALD-701021 FT	32mm dia / 130mm L
ALD-701021 HT	32mm dia / 130mm L

Available Colours  
White, Almond, Apricot



### SMART HANGER

MODEL	SIZE
ALD-701013	203mm
ALD-701014	305mm

Available Colours  
White, Almond, Apricot,  
Green, Light Blue,  
Burgandy



### PVC WASTE PIPE

MODEL	SIZE
ALD-701006	32mm x 750mm
ALD-701007	32mm x 915mm

Available Colours  
White, Almond, Apricot



Hose size: ID 20.3 x Thickness 3 mm





## GARDEN HOSE WITH COLLAR

MODEL	SIZE
ALD-701023	1/2" 30mtr Roll
ALD-701024	3/4" 30mtr Roll
ALD-701038	1" 30mtr Roll
ALD-701025	1/2" 10mtr Roll
ALD-701026	3/4" 10mtr Roll
ALD-701027	1" 10mtr Roll

### Available Colours

Green, Pink



## TECHNICAL SPECIFICATIONS GARDEN HOSE

Burst Pressure - 7 Bar



## GARDEN HOSE WITHOUT COLLAR

MODEL	SIZE
ALD-701028	1/2" 30mtr Roll
ALD-701029	3/4" 30mtr Roll
ALD-701030	1" 30mtr Roll
ALD-701031	1/2" 10mtr Roll
ALD-701032	3/4" 10mtr Roll
ALD-701033	1" 10mtr Roll



# WARRANTY GUIDE

This warranty is not valid or effective if the products are not installed according to the installation guide. Improper handling of the products automatically terminates and nullifies this warranty. Improper care and cleaning will void the warranty.

Warranty period will start from the date of invoice and shall automatically terminate upon the expiry of the warranty period even if the products has not been installed after purchase or has been in the use for any part or whole of the warranty period for any reason whatsoever.

In the event of any repairs / replacement of any parts of the product, this warranty shall thereafter continue and remain in force only for the unexpired period of the warranty and no extension of the warranty period will be granted. This warranty is only applicable for the manufacturing defects and under no circumstances the manufacturer will be liable for any other defect caused due to indirect, incidental and consequential damages of any kind.

This warranty is only effective if the defective product is substantiated with the proof of purchase such as invoice copy / warranty card. This warranty remains applicable only if the product has at all times been used strictly in accordance with the terms of this warranty and has not been improperly or negligently handled.

## WARRANTY DETAILS

PRODUCTS	PARTS	WARRANTY PERIOD	PRODUCTS	PARTS	WARRANTY PERIOD
Faucets	Faucet Body All washers & rubber parts	Residential / commercial use-3 years Not applicable	Over head Showers and Hand showers	Shower Head And Shower Arm All Washers & Rubber Parts	Residential use - 3 years / Commercial use - 2 years Not applicable
Basin Mixer	Basin mixer body 35mm cartridge 450 & 600 mm ss braided hose Rubber washer & rubber components	Residential Use 3 Years / Commercial Use - 2 Years 100,000 Cycles 7 Years Not Applicable	Health Faucets	Rinsing spray body & lever All washers & rubber parts Spring	Residential / Commercial use - 1 year Not applicable Not applicable
Single lever Bath and Shower mixer	Outer plate 40mm maruwa cartridge Neoperl diverter-push type All washers & rubber parts Concealed body	Residential use 10 years / commercial use - 7 years 300,000 cycles Lifetime warranty. Not applicable for physical or lime collection damage Not applicable	Urinal Push Cock	Faucet body Timer cartridge Chrome flexi hose-30cm Rubber washer & rubber components	Residential use - 10 years / Commercial use - 7 years 300,000 Cycles 7 Years Not Applicable
Wall Mixer	Mixer body All washers & rubber parts	Residential use 3 years / commercial use - 2 years Not applicable	Concealed Cistern	Outer Body Internal Fittings	Residential use - 10 years / Commercial use - 7 years Not Applicable
Pressmatic	Faucet body	Residential use - 10 years / Commercial use - 7 years	Flush Cistern And Seat Covers	Internal Fittings	Residential / Commercial use - 2 Years
	Timer cartridge	300,000 Cycles			
	Chrome flexi hose-30cm	7 Years			
	Rubber washer & rubber components	Not Applicable			

## QUALITY POLICY

- Strategise and improve the QMS process with a competent, motivated workforce to satisfy the needs and expectations of all the interested parties and fulfil the applicable statutory/ regulatory requirements.
- Upkeep of brand reputation and trust by offering superior quality and innovative products through continual improvements in design and process of manufacture.

## QUALITY OBJECTIVE

- To adopt/follow the best design and manufacturing practices to achieve the expected quality standard.
- To continuously evaluate and monitor the satisfaction of the interested parties.
- To train the employees on QMS awareness.
- To motivate the employees through involvement and delegation of responsibilities for continual improvement.



ISO 9001 COMPANY



MEMBER OF IPA



06/23

en-WATERTEC Polymer / Subject to technical alterations and colour differences due to the printing process.



watertecind



watertec-ind



Watertecind



watertecindia

**WATERTEC**  
GROUP

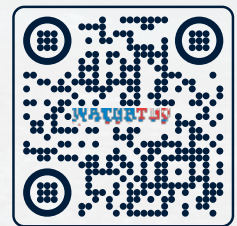

www.watertecindia.com

WATERTEC (INDIA) PVT. LTD. Corporate Office: Gopal Bagh, #1062, Avinashi Road, Coimbatore - 641 018, India.  
Call: +91 422-2243439 (5 Lines) | E-mail: marketing@watertecindia.com | Visit: watertecindia.com

**Toll-free: 1800 121 2191**